

# SMB760-1100-I High Power type Top LED

SMB760-1100-I is an AlGaAs LED mounted on copper heat sink with a 5\*5 mm package  
 These devices are available to be operated and 725mW/sr at IFP=4A.

### ◆ Specifications

- 1) Product Name High Power Top LED
- 2) Type No. SMB760-1100-I
- 3) Chip
  - (1) Chip Material AlGaAs
  - (2) Chip Dimension 1000um\*1000um
  - (3) Chip Number 1pce
  - (4) Peak Wavelength 760nm typ.
- 4) Package
  - (1) Lead Frame Die Silver Plated on Copper
  - (2) Insulator AlN ceramics
  - (3) Package Resin PPA Resin
  - (4) Lens Epoxy Resin

### ◆ Outer dimension (Unit: mm)

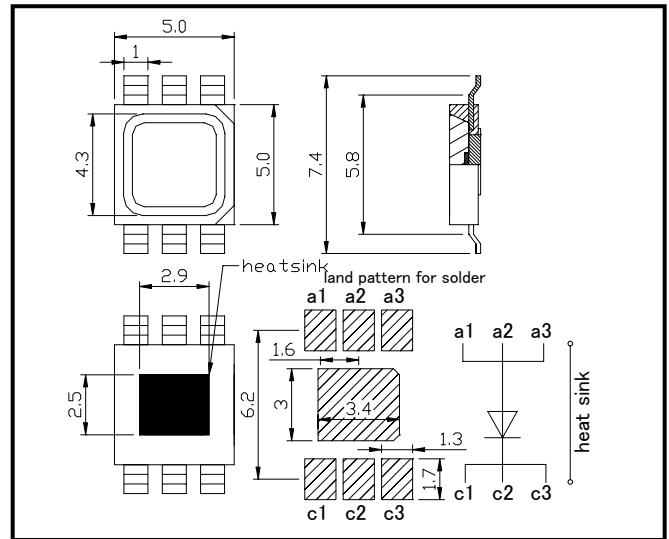

### ◆ Absolute Maximum Ratings

Item	Symbol	Maximum Rated Value	Unit	Ambient Temperature
Power Dissipation	$P_D$	2500	mW	$T_a=25^{\circ}\text{C}$
Forward Current	$I_F$	800	mA	$T_a=25^{\circ}\text{C}$
Pulse Forward Current	$I_{FP}$	4000	mA	$T_a=25^{\circ}\text{C}$
Reverse Voltage	$V_R$	5	V	$T_a=25^{\circ}\text{C}$
Thermal Resistance	$R_{thja}$	10	K/W	
Junction Temperature	$T_j$	100	$^{\circ}\text{C}$	
Operating Temperature	$T_{OPR}$	-30 ~ +85	$^{\circ}\text{C}$	
Storage Temperature	$T_{STG}$	-30 ~ +100	$^{\circ}\text{C}$	
Soldering Temperature	$T_{SOL}$	255	$^{\circ}\text{C}$	

‡Pulse Forward Current condition: Duty=1% and Pulse Width=10us.

‡Soldering condition: Soldering condition must be completed within 5 seconds at 255°C

### ◆ Electro-Optical Characteristics [ $T_a=25^{\circ}\text{C}$ ]

Item	Symbol	Condition	Minimum	Typical	Maximum	Unit
Forward Voltage	$V_F$	$I_F=800\text{mA}$		2.0	2.5	V
	$V_{FP}$	$I_{FP}=4\text{A}$		4.5	5.5	V
Radiated Power	$P_O$	$I_F=800\text{mA}$		330		mW
		$I_{FP}=4\text{A}$		1650		mW
Radiant Intensity	$I_E$	$I_F=800\text{mA}$		145		mW/sr
		$I_{FP}=4\text{A}$		725		mW/sr
Peak Wavelength	$\lambda_P$	$I_F=100\text{mA}$		760		nm
Half Width	$\Delta\lambda$	$I_F=100\text{mA}$		25		nm
Viewing Half Angle	$\theta_{1/2}$	$I_F=100\text{mA}$		$\pm 62$		deg.
Rise Time	$t_r$	$I_F=100\text{mA}$		80		ns
Fall Time	$t_f$	$I_F=100\text{mA}$		80		ns

‡Radiated Power is measured by S3584-08.

‡Radiant Intensity is measured by Tektronix J-6512.

**USHIO EUROPE B.V.** ([www.ushio.eu](http://www.ushio.eu))

Sky Park, Breguetlaan 16-18, 1438 BC, Oude Meer, The Netherlands

Tel: +31-20-4469-333 Fax: +31-20-4469-360 E-mail: [led@ushio-europe.nl](mailto:led@ushio-europe.nl)

**Forward Current - Forward Voltage**

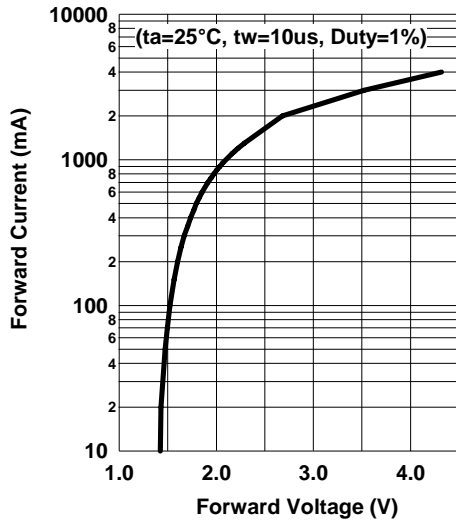

**Relative Radiant Intensity - Forward Current**

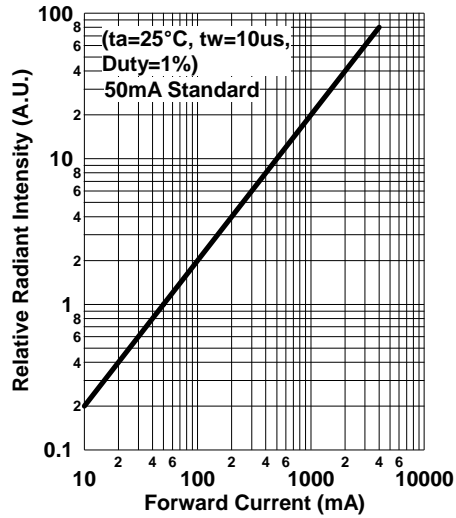

**Forward Current-Pulse Duration**

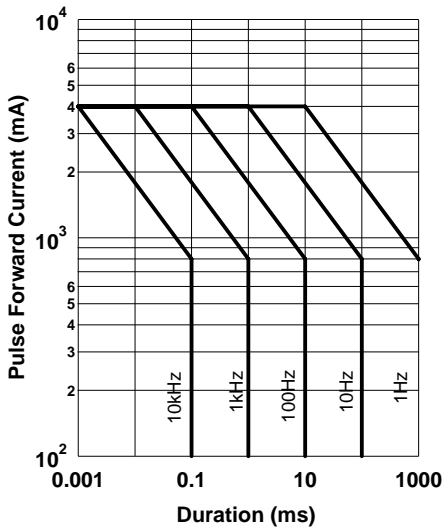

**Allowable Forward Current - Ambient Temperature**

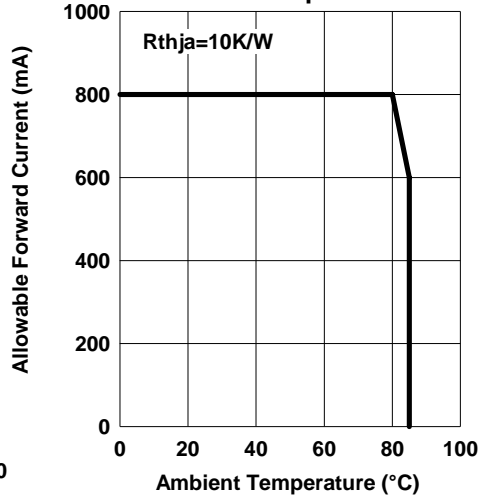

**Relative Spectral Emission**

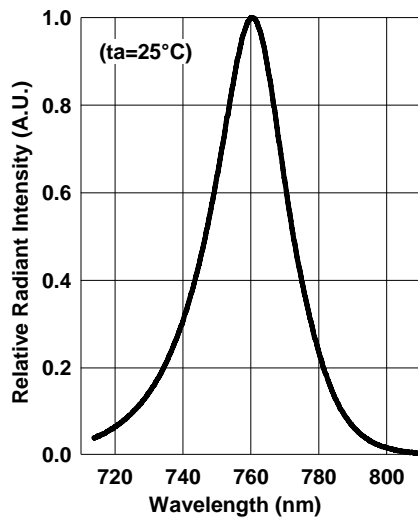

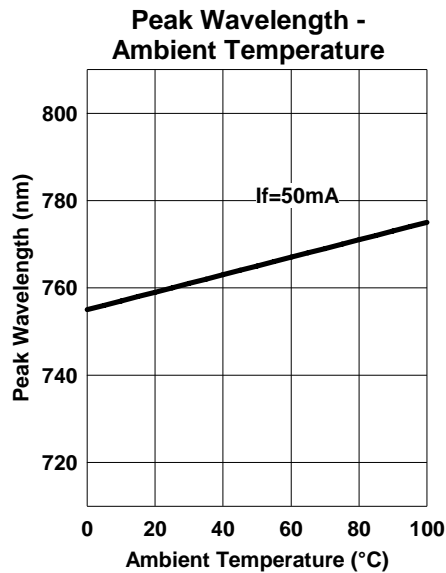
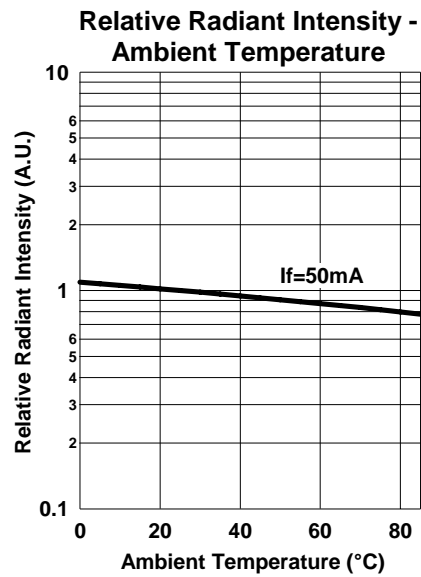
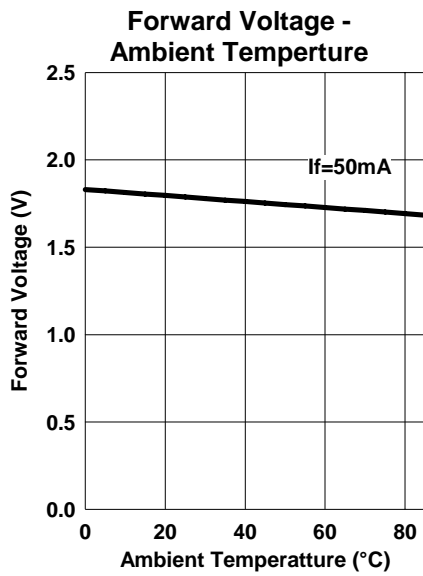

◆ Wrapping

Moisture barrier bag aluminum laminated film with a desiccant to keep out the moisture absorption during the transportation and storage.

Radiation Pattern

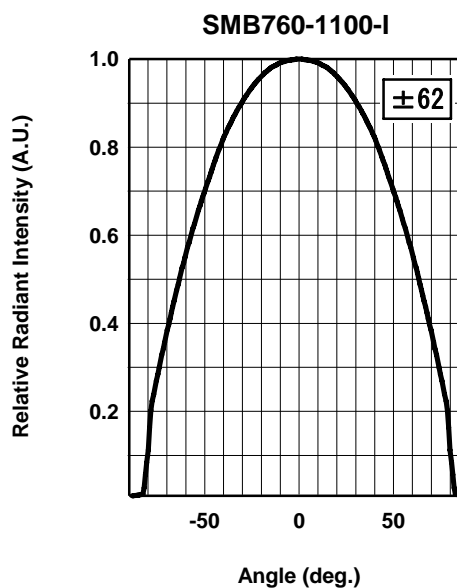
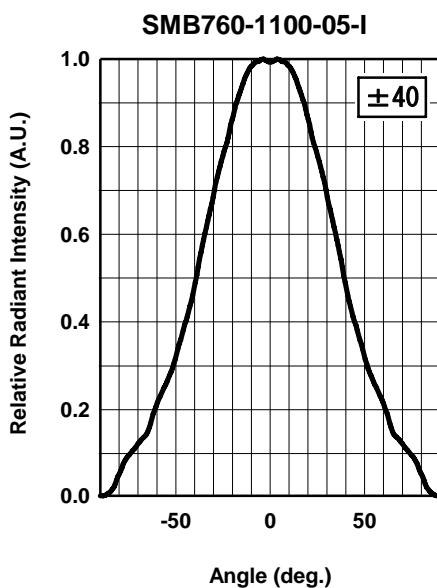
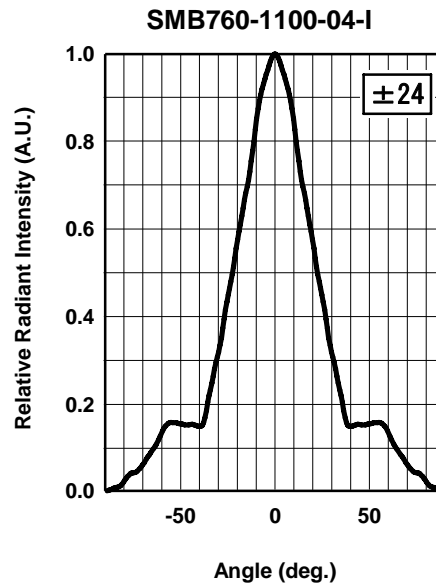
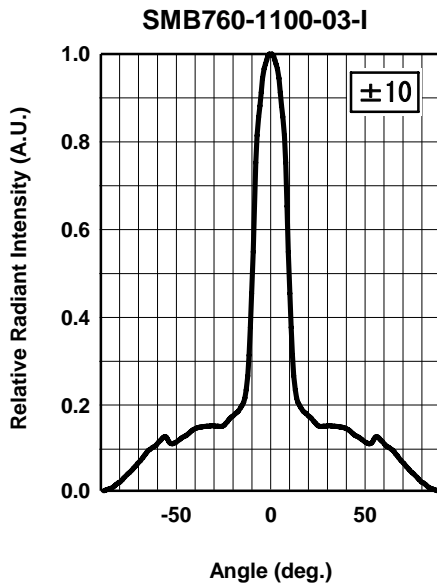
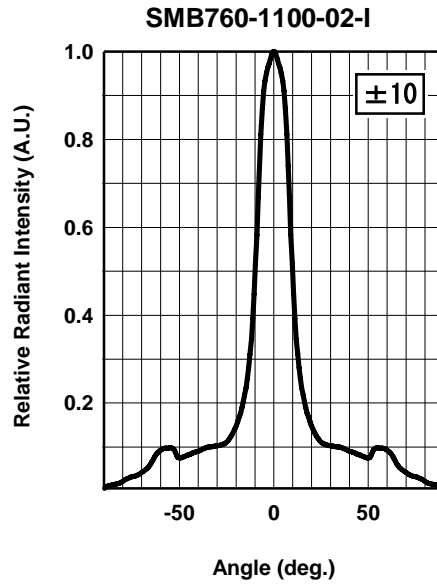
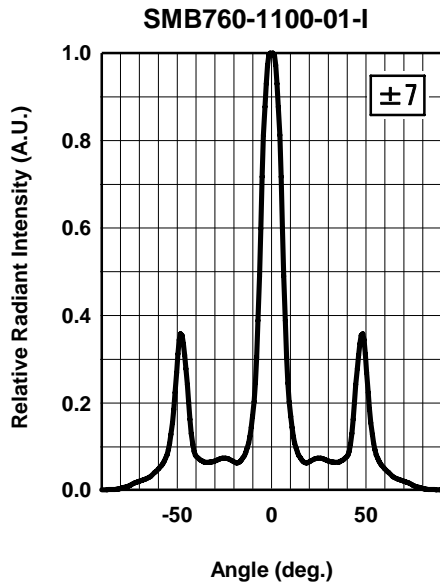



Radiation Pattern

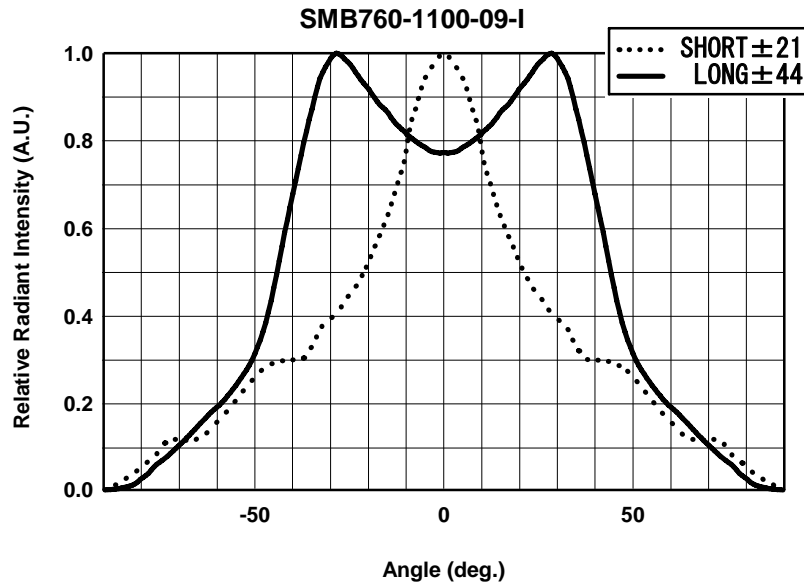

## SMD LED STORAGE AND HANDLING PRECAUTIONS

### < Storage Conditions before Opening a Moisture-Barrier Aluminum Bag >

- Before opening a moisture-barrier aluminum bag, please store it at <30°C, <60%RH. Please note that the maximum shelf life is 12 months under these conditions.

### < Storage Conditions after Opening a Moisture-Barrier Aluminum Bag >

- After opening a moisture-barrier aluminum bag, store the aluminum bag and silica gel in a desiccator.
- After opening the bag, please solder the LEDs within 72 hours in a room with 5 - 30°C, <50%RH.
- Please put any unused, remaining LEDs and silica gel back in the same aluminum bag and then vacuum-seal the bag.
- It is recommended to keep the re-sealed bag in a desiccator at <30%RH.

### < Notes about Re-sealing a Moisture-Barrier Aluminum Bag >

- When vacuum-sealing an opened aluminum bag, if you find the moisture-indicator of the silica gel has changed to pink from blue (indicating a relative humidity of 30 % or more), please do not use the unused LEDs, the aluminum bag, or the silica gel.

### < Notes about Opening a Re-sealed Moisture-Barrier Aluminum Bag >

- When opening a vacuumed and re-sealed aluminum bag in order to use the remaining LEDs stored in the bag, if you find that the moisture-indicator of the silica has changed to pink, please do not use the LEDs.

※The 72-hour- long floor life does not include the time while LEDs are stored in the moisture-barrier aluminum bag.

However, we strongly recommend to solder the LEDs as soon as possible after opening the aluminum bag.